



8905-TM/9505-TM

Multiplicadores de torque manuales con brazos de reacción rectos y acodados de 2700 Nm



DETALLES DEL PRODUCTO

- La gama cubre un torque de salida máx. de hasta 2700 N.m
- Siempre utilice con llave dinamométrica (sentido horario y antihorario) para evitar exceder el torque máximo de los multiplicadores
- Precisión ± 4
- Se suministra con brazos de reacción acodados y rectos
- Se suministra en caja moldeada por soplado portátil
- Hecha en Reino Unido

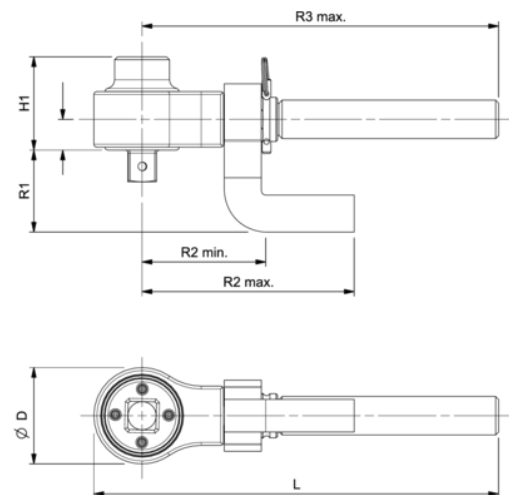









Follow the Fish!











ATRIBUTOS DE PRODUCTO

Producto: 8905-TM

 1300 N·m	 3/4 in	 5:1			
 260 N·m	 in	D	108 mm		
R3 max mm	344 mm	H1 mm	103 mm	L	210 mm
R2 max mm	212 mm	R2 min mm	140 mm	R1 mm	77 mm
 3.8 kg		1.06 kg		1.36 kg	
 3.700 kg					

Producto: 9505-TM

 2700 N·m	 1 in	 5:1			
 540 N·m	 in	D	108 mm		
R3 max mm	344 mm	H1 mm	100 mm	L	210 mm
R2 max mm	212 mm	R2 min mm	140 mm	R1 mm	85 mm
 3.8 kg		1.06 kg		1.36 kg	
 3.700 kg					

Follow the Fish!

