



**2477G-200**

**Alicates de punta doblada 45° con mangos de dos componentes y acabado lacado**



## DETALLES DEL PRODUCTO

- Capacidad de corte: 3 mm de cable de Cu, 1.5 mm de Fe+ y 1 de cable de piano
- Aleación de acero de alto rendimiento
- Pulido y lacado para protegerlo mejor de la oxidación
- Con puntas dobladas en ángulo de 45°, mangos de dos componentes
- Bocas estrechas, semicirculares y serradas
- Filos de corte afilados para cortar material blando como cobre y cable plástico aislado
- Normas: ISO 5745

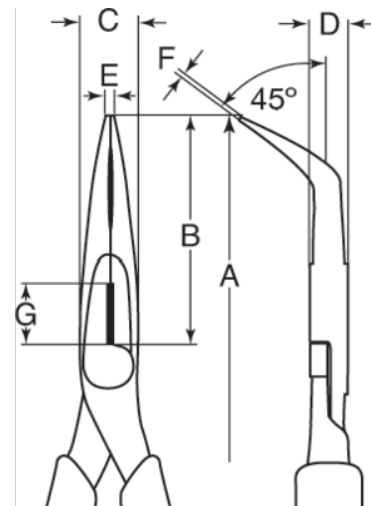





**Follow the Fish!**







## ATRIBUTOS DE PRODUCTO

Producto: **2477G-160**

<b>A</b>	165 mm	<b>B</b>	48 mm	<b>C</b>	18 mm
<b>D</b>	9 mm	<b>E</b>	3 mm	<b>F</b>	2 mm
<b>G</b>	48 mm	 Cu	3.0 mm	 Fe+	1.5 mm
 Piano	1 mm	 g	160 g		

Producto: **2477 G-200**

<b>A</b>	210 mm	<b>B</b>	70 mm	<b>C</b>	22 mm
<b>D</b>	11 mm	<b>E</b>	4 mm	<b>F</b>	3 mm
<b>G</b>	70 mm	 Cu	3.0 mm	 Fe+	1.5 mm
 Piano	1 mm	 g	185 g		

Follow the Fish!

